

Axial Lead Transient Voltage Suppressors (TVS)

15KP Series 17 To 280 V 15000W

Description

The 15KP series is designed specifically to protect sensitive electronic equipment from voltage transients induced by lightning and other transient voltage events.

Features

- u Glass passivated chip junction in P600 Package
- u Low leakage
- u Uni and Bidirectional unit
- u Excellent clamping capability
- u 15000W Peak power capability at 10 × 1000µs waveform Repetition rate (duty cycle):0.01%
- u Fast response time: typically less than 1.0ps from 0 Volts to V_{BR} min
- u Typical I_R less than 2µA above 40V.
- u High Temperature soldering: 260°C/40 seconds at terminals
- u Typical maximum temperature coefficient $\Delta V_{BR} = 0.1\% \times V_{BR}@25^\circ\text{C} \times \Delta T$
- u Plastic package has Underwriters Laboratory Flammability 94V-0
- u Matte tin lead-free Plated
- u Halogen free and RoHS compliant
- u Typical failure mode is short from over-specified voltage or current
- u Whisker test is conducted based on JEDEC JESD201A per its table 4a and 4c
- u IEC-61000-4-2 ESD 15kV(Air), 8kV (Contact)
- u ESD protection of data lines in accordance with IEC 61000-4-2 (IEC801-2)
- u EFT protection of data lines in accordance with IEC 61000-4-4 (IEC801-4)

Uni-directional

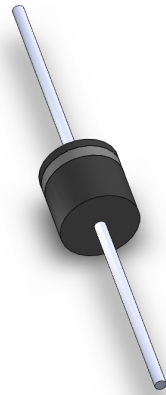

Bi-directional

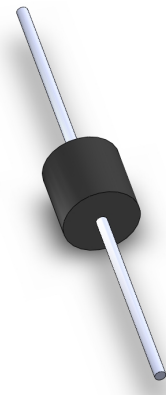

Functional Diagram

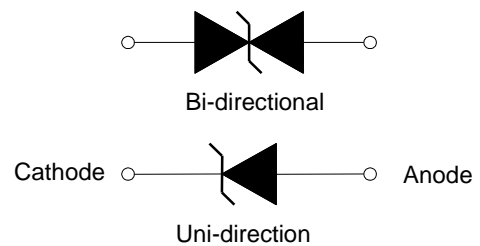

Applications

TVS devices are ideal for the protection of I/O interfaces, V_{CC} bus and other vulnerable circuits used in Telecom, Computer, Industrial and Consumer electronic applications.

Maximum Ratings ($T_A=25^\circ\text{C}$ unless otherwise noted)

Parameter	Symbol	Value	Unit
Peak Pulse Power Dissipation with a 10/1000µs waveform (Fig.1)(Note 1), (Note 2)	P_{PPM}	15000	Watts
Peak Pulse Current with a 10/1000µs waveform.(Note1, Fig.3)	I_{PP}	See Next Table	Amps
Power Dissipation on Infinite Heat Sink at $T_L=75^\circ\text{C}$	$P_{M(AV)}$	8.0	Watt
Peak Forward Surge Current, 8.3ms Single Half Sine Wave (Note 3)	I_{FSM}	500	Amps
Operating junction and Storage Temperature Range.	T_J, T_{STG}	-55 to +150	$^\circ\text{C}$

Notes:

1. Non-repetitive current pulse, per Fig. 3 and derated above $T_A = 25^\circ\text{C}$ per Fig. 2.
2. Mounted on 5.0mm x 5.0mm (0.03mm thick) Copper Pads to each terminal.
3. 8.3ms single half sine-wave, or equivalent square wave, Duty cycle = 4 pulses per minutes maximum.
4. $V_F < 3.5\text{V}$ for $V_{BR} < 200\text{V}$ and $V_F < 6.5\text{V}$ for $V_{BR} > 201\text{V}$.

Axial Lead Transient Voltage Suppressors (TVS)

15KP Series 17 To 280 V 15000W
Electrical Characteristics (T_A=25°C unless otherwise noted)

Part Number		Reverse Stand-Off Voltage V _{RWM} (V)	Breakdown Voltage V _{BR} (V) @I _T		Test Current I _T (mA)	Maximum Clamping Voltage V _C @I _{PP} (V)	Maximum Peak Pulse Current I _{PP} (A)	Maximum Reverse Leakage I _R @V _{RWM} (μA)
Uni	Bi		MIN	MAX				
15KP17A	15KP17CA	17	18.99	20.79	50	29.3	515.4	5000
15KP18A	15KP18CA	18	20.11	22.01	50	30.9	488.7	5000
15KP20A	15KP20CA	20	22.34	24.46	20	34.3	440.2	1500
15KP22A	15KP22CA	22	24.57	26.91	10	37.1	407.0	500
15KP24A	15KP24CA	24	26.81	29.35	5	40.7	371.0	150
15KP26A	15KP26CA	26	29.04	31.80	5	44.0	343.2	50
15KP28A	15KP28CA	28	31.28	34.24	5	47.5	317.9	25
15KP30A	15KP30CA	30	33.51	36.70	5	50.7	297.8	15
15KP33A	15KP33CA	33	36.90	40.40	5	54.7	276.1	2
15KP36A	15KP36CA	36	40.20	44.00	5	59.8	252.5	2
15KP40A	15KP40CA	40	44.70	48.90	5	65.8	229.5	2
15KP43A	15KP43CA	43	48.00	52.60	5	69.8	216.3	2
15KP45A	15KP45CA	45	50.30	55.00	5	72.8	207.4	2
15KP48A	15KP48CA	48	53.60	58.70	5	77.7	194.3	2
15KP51A	15KP51CA	51	57.00	62.40	5	82.9	182.1	2
15KP54A	15KP54CA	54	60.30	66.00	5	87.7	172.2	2
15KP58A	15KP58CA	58	64.80	70.90	5	93.8	161.0	2
15KP60A	15KP60CA	60	67.00	73.40	5	97.4	155.0	2
15KP64A	15KP64CA	64	71.50	78.30	5	104.2	144.9	2
15KP70A	15KP70CA	70	78.20	85.60	5	113.6	132.9	2
15KP75A	15KP75CA	75	83.80	91.70	5	122.0	123.8	2
15KP78A	15KP78CA	78	87.10	95.40	5	126.1	119.7	2
15KP85A	15KP85CA	85	94.90	104.00	5	137.6	109.7	2
15KP90A	15KP90CA	90	100.50	110.10	5	145.6	103.7	2
15KP100A	15KP100CA	100	111.70	122.30	5	161.3	93.6	2
15KP110A	15KP110CA	110	122.90	134.50	5	178.6	84.5	2
15KP120A	15KP120CA	120	134.00	146.80	5	192.3	78.5	2
15KP130A	15KP130CA	130	145.20	159.00	5	208.3	72.5	2
15KP150A	15KP150CA	150	167.60	183.50	5	241.9	62.4	2
15KP160A	15KP160CA	160	178.70	195.70	5	258.6	58.4	2
15KP170A	15KP170CA	170	189.90	207.90	5	272.7	55.4	2
15KP180A	15KP180CA	180	201.10	220.10	5	288.5	52.3	2
15KP200A	15KP200CA	200	223.40	244.60	5	319.1	47.3	2
15KP220A	15KP220CA	220	245.70	269.10	5	428.6	42.2	2
15KP240A	15KP240CA	240	268.10	293.50	5	384.6	39.3	2
15KP260A	15KP260CA	260	290.40	318.00	5	416.7	36.2	2
15KP280A	15KP280CA	280	312.80	342.40	5	454.5	33.2	2

Note:

- For Bi-Directional devices having V_R of 30 volts and under, the I_R limit is double

Axial Lead Transient Voltage Suppressors (TVS)

15KP Series 17 To 280 V 15000W

Ratings and Characteristic Curves ($T_A=25^\circ\text{C}$ unless otherwise noted)

Figure 1 - Peak Pulse Power Rating Curve

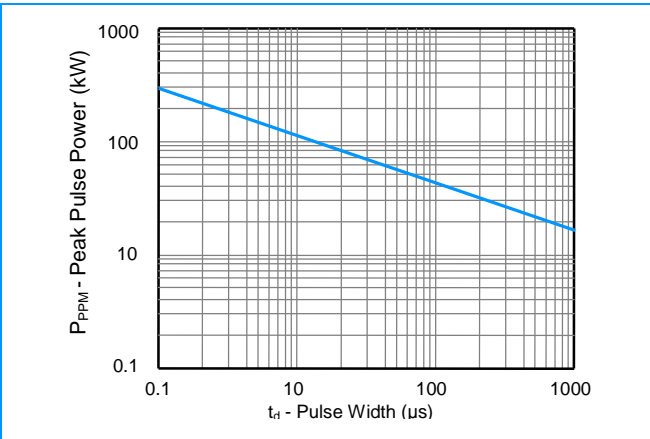

Figure 2 - Pulse Derating Curve

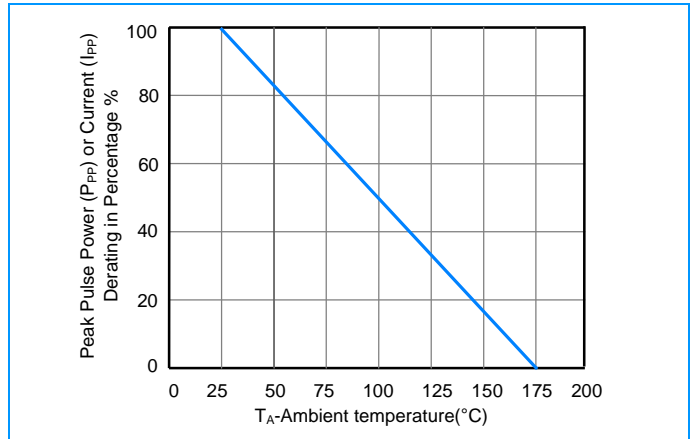

Figure 3 - Pulse Waveform

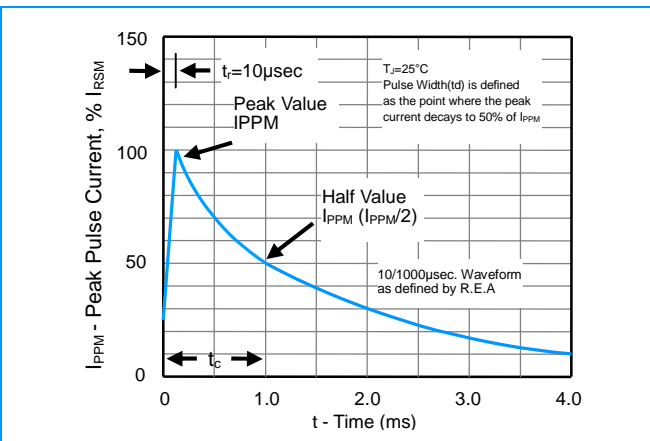

Figure 4 - Typical Junction Capacitance

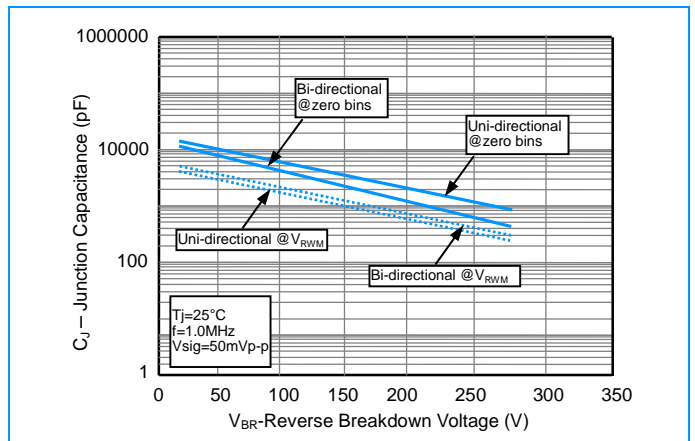

Figure 5 - Steady State Power Derating Curve

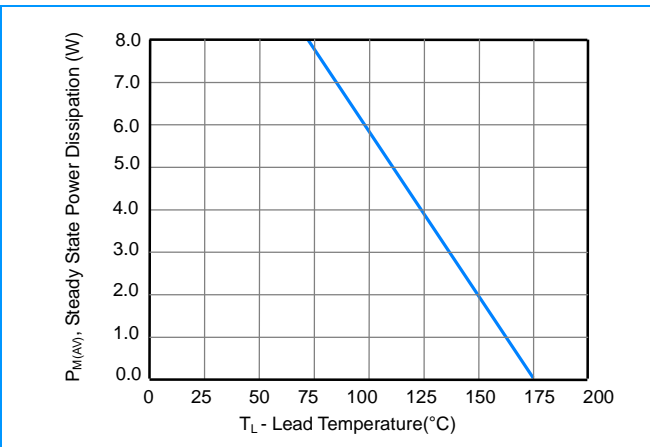
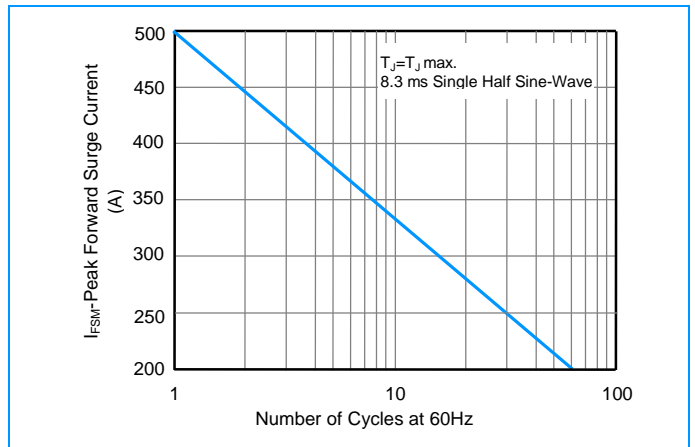

Figure 6 - Maximum Non-Repetitive Surge Current



Axial Lead Transient Voltage Suppressors (TVS)

15KP Series 17 To 280 V 15000W

I-V Curve Characteristics

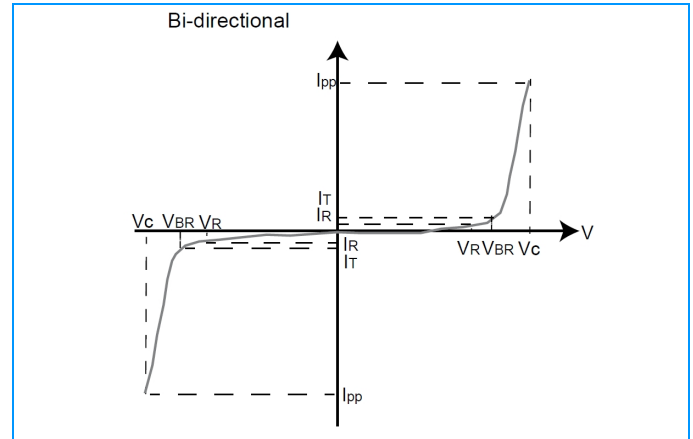
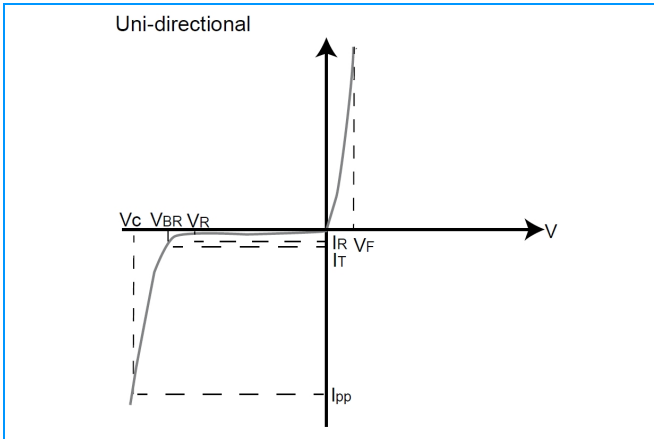

Physical Specifications

Weight	0.07 ounce, 2.1gram
Case	JEDEC R-6/P600 Molded Plastic over glass passivated junction
Polarity	Color band denotes cathode except Bipolar
Terminal	Matte Tin-plated leads, Solderable per JESD22-B102D

Environmental Specifications

Temperature Cycle	JESD22-A104
Pressure Cooker	JESD22-A102
High Temp. Storage	JESD22-A103
HTRB	JESD22-A108
Thermal Shock	JESD22-A106

Soldering Parameters

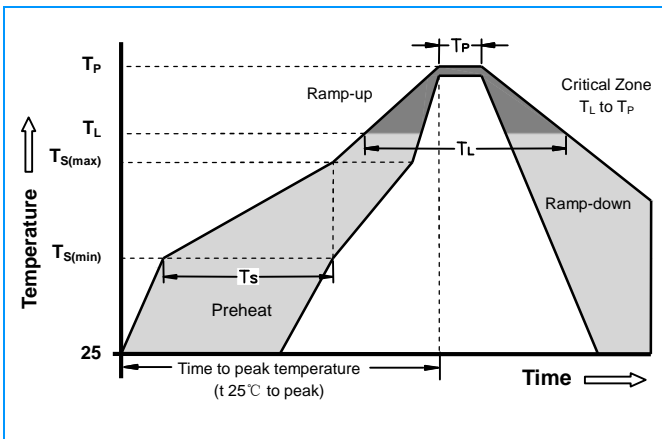

Reflow Condition		Lead-free assembly
Pre Heat	-Temperature Min ($T_{s(min)}$)	150°C
	-Temperature Max ($T_{s(max)}$)	200°C
	- Time (min to max) (t_s)	60 -180 Seconds
Average ramp up rate (Liquidus Temp T_L) to peak		3°C/second max
$T_{s(max)}$ to T_L - Ramp-up Rate		3°C/second max
Reflow	- Temperature (T_L) (Liquidus)	217°C
	- Time (min to max) (t_s)	60 -150 Seconds
Peak Temperature (T_P)		260 +0/-5°C
Time within 5°C of actual peak Temperature (t_p)		20 -40 Seconds
Ramp-down Rate		6°C/second max
Time 25°C to peak Temperature (T_P)		8 minutes Max
Do not exceed		280°C

Axial Lead Transient Voltage Suppressors (TVS)

15KP Series 17 To 280 V 15000W

Dimensions

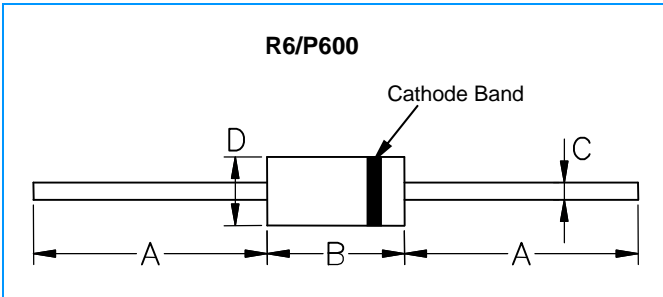

Dimensions	Inches		Millimeters	
	Min	Max	Min	Max
A	1.000	-	25.40	-
B	0.340	0.360	8.64	9.14
C	0.048	0.052	1.22	1.32
D	0.340	0.360	8.64	9.14

Part Numbering

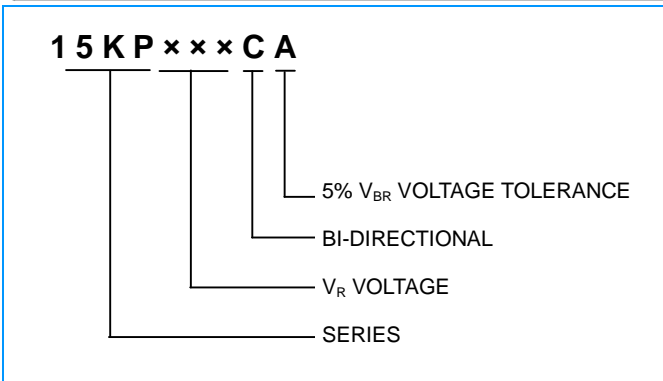

Packaging

Part Number	Component Package	Quantity	Packaging Option
15KPXXXXX	R6/P600	200	Box

Packaging Dimensions Unit: Inches (Millimeters)

